

# Operating Manual for GRAF Fluid bed XXL- Waste Water Treatment System

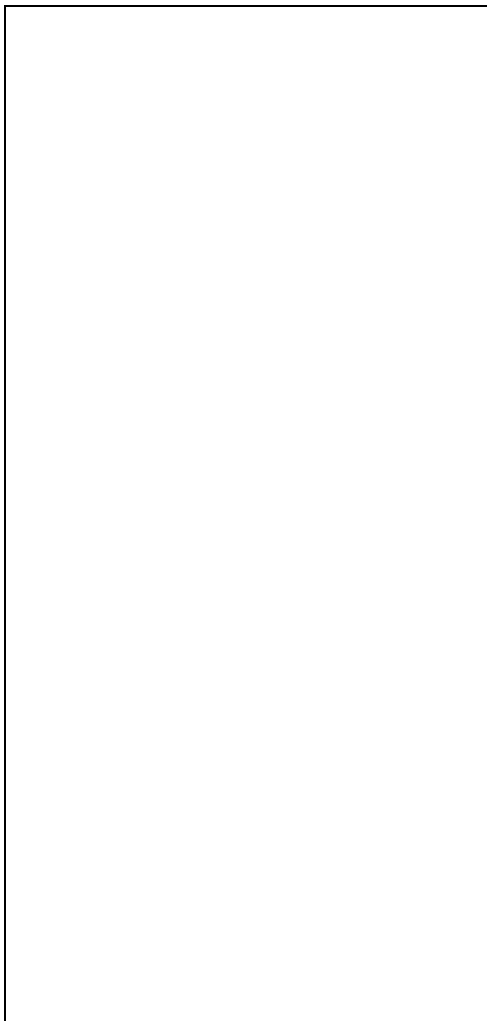
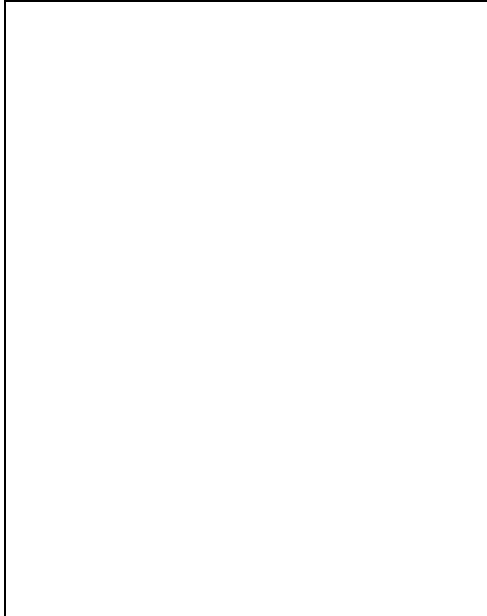

## Table of contents

1.	INFORMATION ON THE PLANT	3
2.	SCOPE OF DELIVERY	5
3.	SCOPE OF DELIVERY	6
4.	CONTROL AND SWITCH CABINET	7
5.	INITIAL OPERATION	9
6.	OPERATION OF THE CONTROL UNIT	10
7.	ADDITIONAL FUNCTIONS OF THE CONTROL UNIT ZK PLUS	19
8.	MAINTENANCE AND OPERATION	20
9.	FAULT INDICATIONS AND FAULT REPAIR	23
10.	OPERATING INSTRUCTIONS	25
11.	ATTACHMENT I: FORM FOR WEEKLY / MONTHLY CHECKMARKS	27
12.	MAINTENANCE MINUTES FOR GRAF SMALL SEWAGE TREATMENT PLANTS	30
13.	ATTACHMENT I: DATASHEETS OF THE PLANT	32

# WARRANTY CERTIFICATE

Otto Graf GmbH  
Kunststofferzeugnisse



Dear Sir or Madam,

Congratulations on purchasing a quality product from Otto Graf GmbH. We hereby confirm that there is a

**3-year**

warranty on the small waste water treatment system you have purchased

The warranty applies to the purifying technology only. Accessories and optional additions are not covered by the warranty. During the warranty period, Otto Graf GmbH provides free material replacement; but services extended beyond this are not covered.

## Warranty conditions

The warranty applies under the following conditions:

1. The waste water treatment system must be installed and commissioned by a specialist firm. Companies certified by the DWA (German Association for Water, Wastewater and Waste) or trained by Otto Graf GmbH are recognised as specialist firms.
2. Maintenance must be carried out in accordance with the logbook and approved by a specialist. In the case of warranty claims, all maintenance reports must be submitted on request.
3. Wearing parts and any defects or damage not caused by us resulting from improper operation of the system, maintenance not being carried out, faults caused by the customer and unauthorised changes to the system are not covered by the guarantee.
4. Any follow-up costs incurred by replacing the device, shutting down the system etc. are not included in the warranty.

In addition to the warranty any legal entitlements resulting from the guarantee continue to apply without restriction.

Teningen, February 2009

Otto GRAF GmbH  
Carl-Zeiss-Str. 2-6  
D-79331 Teningen  
[www.graf.info](http://www.graf.info)

## 1. Information on the Plant

In case of any further questions which might arise when using the plant, please enter the data of your plant as follows. With this information our service personnel can help you faster if there is any fault.

Number of order confirmation:	<u>    A    </u>
Serial number of plant:	<u>   200   </u>
Serial number of control unit:	<u>   200   </u>
Serial number of air compressor:	<u>          </u>
Compressor type:	<u>          </u>
Number of people	<u>          PE    </u>

Dear Ladies and Gentlemen,

thank you for purchasing the modern GRAF Fluid bed XXL- Waste Water Treatment System. We would like to give you a few important details for long and safe operation:

- The GRAF Fluid bed XXL- Waste Water Treatment System is destined for the discharge of the entire domestic sewage water. The discharge of any other sewage water, e. g. sewage water from restaurants/pubs and/or commercial businesses etc., is only permitted if this discharge was already known and considered when dimensioning the plant.
- Biocides, toxic or biologically not compatible substances must not be discharged into the plant as they impede the bacteria which are important for the clarification of sewage water and cause problems in the biological process (detailed information is given on the following pages). **In order to observe the official clarification requirements it is urgently required to operate the plant according to our operating and maintenance instructions.** You will find these instructions on the following pages.

Moreover we ask you to carefully read and consider the following information:

- The location of switch cabinets for indoor mounting must be a dry, well-aerated room (basement or garage).
- If possible switch cabinets for outdoor mounting should be placed in a location without being exposed to direct sunlight to avoid overheating in summer.
- It must be constantly guaranteed that the cabinet and especially its aeration openings on the sides (indoor cabinet) and on the back (outdoor cabinet) are not covered and are accessible in case of maintenance work.
- Power supply must be permanently ensured. Please make sure that the switch cabinet is sufficiently secured (16 A). Additional power consumers at the same fuse may impede operation.

Otto Graf GmbH in Teningen (Germany).

## 2. Scope of delivery

The waste water treatment system consists of the Carat septic tanks, the fluid bed set-up kit, the carrier material and the control cabinet. These septic tanks with the set-up kit are connected by air hoses laid in the ground.

The septic tanks are divided into three areas: preliminary sedimentation, the bio-reactor, and final sedimentation. Systems for 90 inhabitants or more also have a sludge accrual tank.

The preliminary sedimentation tanks contain:

- T-pieces on the overflow to the next tank as an outlet baffle

The fluid bed tank contains:

- Inlet baffle with holes (these prevent the carrier material from passing back into the preliminary sedimentation tank)
- Air distributor system made of stainless steel with membrane pipes or aerator plates
- Outlet baffle with slots
- Carrier material

The final sedimentation tank contains:

- Inlet baffle
- Sludge lifters consisting of connectable HT pipes which transport excess sludge back to final sedimentation.
- Outlet baffle
- Systems with only one final sedimentation tank require a dividing wall in this tank. The dividing wall is fitted with a DN 70 overflow baffle.

The control cabinet, which is fitted on an inside wall or in the control column outside, contains:

- A low-noise, low-maintenance air compressor
- A valve unit
- A control unit which satisfies VDE 0113 Part 1 and VBG 4.

Please refer to the following table for electrical characteristic values, compressor data and control cabinet dimensions:

Inhabitants	20	28	36	44	50	70	90	120	140	160	200
Compressor type	LP 200	DT 4.10	DT 4.10	DT 4.16	DT 4.25	DLT 40	KDT 3.60	KDT 3.60	KDT 3.80	KDT 3.100	KDT 3.140
Power [kW]	0,26	0,23	0,23	0,44	0,80	1,5	2,4	2,4	2,4	4,0	5,5
Voltage	1~ 220 V	1~ 220 V	1~ 220 V	1~ 220 V	1~ 220 V	3~ 400 V	3~ 400 V	3~ 400 V	3~ 400 V	3~ 400 V	3~ 400 V
Control unit	ZK	ZKplus	ZKplus	ZKplus	Zkplus	Zkplus	Zkplus	Zkplus	Zkplus	Zkplus	Zkplus
Control cabinet dimensions <sup>1)</sup> [l x w x d cm]	50x50x30	60x60x35	60x60x35	60x60x35	80x70x50	80x70x50	Compressor installed on ground, solenoid valves and control cabinet mounted on wall				

<sup>1)</sup> You have to install the compressor in a technical room if one of the compressor type line KDT is used

### 3. Scope of delivery

The system consists of several preliminary sedimentation tanks. Settleable materials settle in the preliminary sedimentation stage while floating materials are held back. An outlet scum baffle is fitted on the outlet pipe of each preliminary sedimentation tank. After the preliminary sedimentation tanks, the waste water flows into one or more fluid bed tanks where biological cleaning is carried out.

The waste water enters the fluid bed tank through an inlet scum baffle which prevents the carrier material passing back into the preliminary sedimentation tanks. There is also a baffle on the outlet side which prevents the carrier material being flushed out of the tank. There are several membrane pipe aerators on the base of the tank which bring in air.

After the biological stage, the water flows into the final sedimentation tank(s). The excess sludge is deposited in the final sedimentation tanks and is pumped back to preliminary sedimentation via an air lift pump. In systems sized for 90 or more inhabitants, the sludge is returned to a separate sludge accumulator tank. The final sedimentation tanks feature an outlet scum baffle to retain floating particles.

In systems with separate sludge accumulator tanks, the sludge accumulator overflows into the 2<sup>nd</sup> preliminary sedimentation tank via the dome shaft.

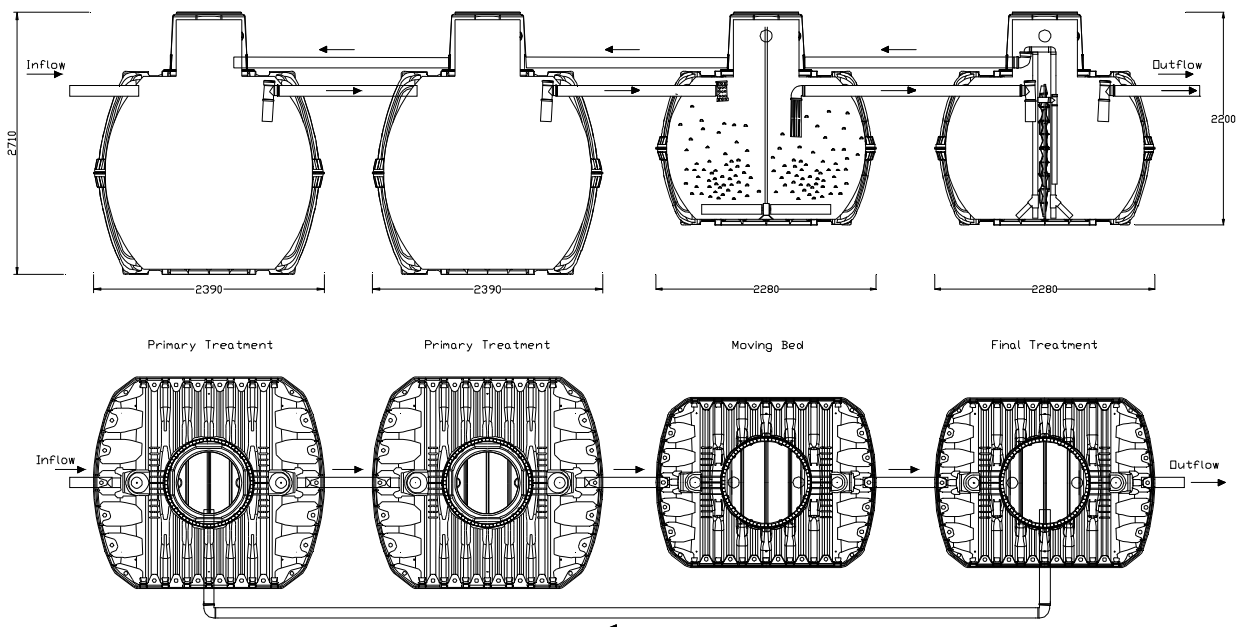

**Important:** All chambers / tanks must be aerated in accordance with DIN 4261-1. This is generally achieved using the waste water line aerated through the roof. Additional ventilation lines or ventilation openings must be installed if necessary. The ventilation lines must be arranged such as to allow natural ventilation (flue effect).

## 4. Control and switch cabinet

All mechanical and electrical components of the plant are installed in a switch cabinet. The cabinet for indoor mounting consists of a powder-coated metal cabinet; in case of outdoor mounting the components are installed in a column made of plastic. The cabinet contains the control unit as well as all required machine elements. The cabinet is opened with the key, which is also included in the delivery, by turning the key clockwise.

### 4.1 Technical components

The main parts of the machine unit are:

- Air compressor,
- Valve unit with 1 or 2 solenoid valves to distribute the air for the aeration and the sludge return line,
- Control unit for automatic operation with preset work cycles,
- Cooling fan (for systems with a rotary vane compressor only).

The externally visible components of the control unit are:

- keyboard for operating the control unit,
- liquid crystal display for two-digit indication of operating situations and fault reports,
- 1 light emitting diode (operation control) for optical indication of operation (green/red).

### 4.2 Switch cabinet

#### 4.2.1 Metal cabinet for indoor mounting

The switch cabinet is prepared for wall mounting. It is to be screwed to the wall in a dry, dust-free and well-aerated room (cellar or garage). For this purpose the wall holders, which are included in the delivery, have to be fixed on the back of the cabinet. A socket 230 V (16A, slow-blow fuse) must be situated close to the cabinet. At the right-hand side there is the feeder with a main switch and an aeration grid. At the left-hand side the hose connections and an aeration grid as well are mounted.

The cabinet should always be accessible, the aeration openings in particular have to be kept easily accessible at any time.

Large plants for more than 40 PE are delivered with a two-door cabinet for ground-mounting.

Plants which are operated with 380 V three-phase current have to be connected by an electrician according to a terminal connection diagram which is also included in the delivery. The direction of rotation of the compressor has to be considered at any rate.



## 4. Control and switch cabinet

### 4.2.2 Plastic cabinet for outdoor mounting

Control cabinets installed outside require a concrete foundation. Please contact Otto Graf GmbH for dimensions.



Picture 1 Indoor switch cabinet - interior view



Picture 2 Two-door concrete cabinet - inside

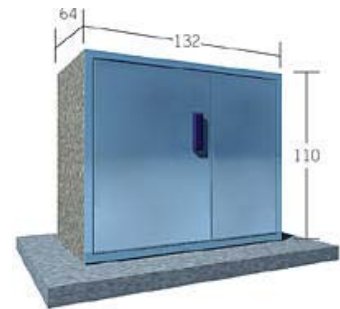

Picture 3 Two-door concrete cabinet

After being laid in the ground between the system and the control cabinet, the two air hoses should be trimmed to the required length and secured on or in the control cabinet. When making the connections, ensure that the hoses are attached to the grommets with the right colour marking. The connections of the same colours should always be joined together and fixed with hose fittings.

**After having laid and connected the hoses, the empty conduit has to be closed gas-tight with a sealing insert by GRAF or PU foam so that a gas exchange through this conduit is excluded (Ex-protection, dampness, smells!).**



## 5. Initial operation

When commissioning the plant (i. e. after mounting is finished) all chambers, if not filled already, have to be filled up to the bottom edge of the outlet.

### 5.1 Initial operation of the cabinet

After having connected the plant to the power supply system, turn the main switch to position „1“.

The plant is running a short test which lasts a few seconds and then automatically starts normal operation (automatic). During the test the indication „SYSTEM TEST ... OK“, the programme version and the serial number of the control unit will appear in the display for a short period of time. Afterwards the current operational state of the plant is shown in the liquid crystal display. If a battery has not yet been inserted in the control unit and date and time have not yet been set, the control unit indicates fault reports. These can be acknowledged by pressing the Esc key. Afterwards date and time can be set using the menu (see further down).

Afterwards a functional test of the control unit, the three lifters, the aeration and the cabinet aeration, in case there is one, should be made. This test can be made via the menu item “manual operation” provided in the control unit.

**Caution:** Operation of the lifters is only possible when the tanks are filled.

After a successful check of the plant it has to be reset to automatic operation.

### 5.2 Plant characteristics after turning off the power supply

If the plant is separated from the power supply system (e. g. due to power failure) the control programme and the counted operating hours will remain in the plant's control unit memory. There is an intermittent warning sound. This warning sound will only start after a few seconds' delay (see point 9.3, power failure warning device). If the plant is supplied with power again, an automatic start of the plant will occur as mentioned above. It is a precondition that a sufficiently charged battery was set in the control unit.

#### **Important note:**

If the plant is separated from the power supply system for more than 24 hours, clarification of the existing sewage water is not possible or can only be achieved at a much lesser extent.

## 6. Operation of the control unit

Operation of the plant is executed by the control unit in the cabinet door (or inside the cabinet in case of outdoor cabinets). It allows the setting of operational parameters, the display of operating situations and reading of information on plant parameters as well as programming of operating periods by an expert company. With indoor switch cabinets the cabinet does not have to be opened for operating the plant.

The following pictures show the composition of the control units.

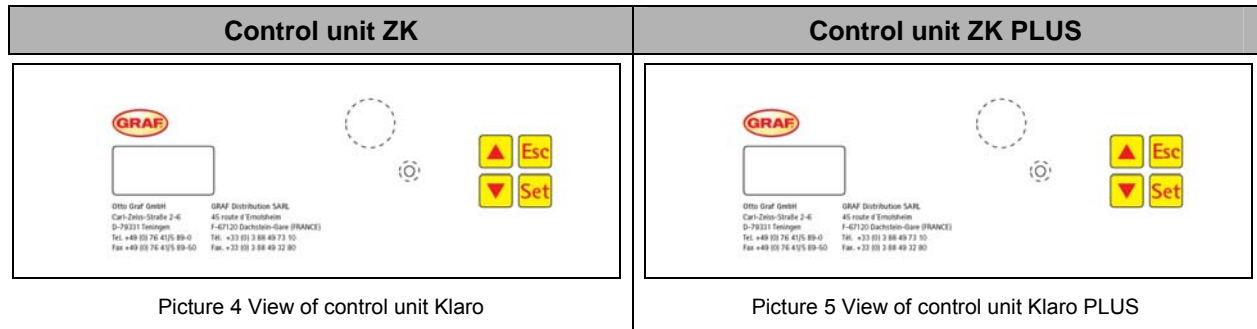

### Indication of operational state

The operational state of the plant is indicated by the light-emitting diode (green = operation / red = fault) and as text on the LC screen.

In the normal operational mode (aeration mode) the liquid crystal display looks as follows:



Picture 6 View of liquid crystal display during the aeration phase

In automatic operation the liquid crystal display indicates the current work phase and the time remaining in this work stage.

If a fault occurs, the liquid crystal display will indicate which component is affected by the fault (e. g. error compressor).

→ **Note:** Characteristics in case of a fault are described in greater detail under point 9.

The following work phases are shown:





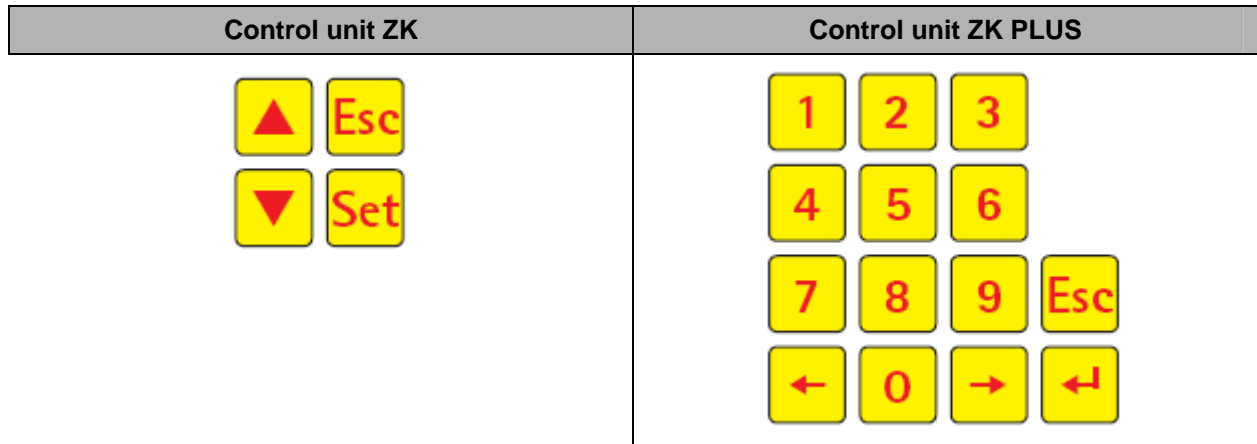

Display	Operation carried out	Display
Aerate	Valve 2 is activated, the bioreactor is aerated at intervals,	Aeration
Discharge	Valve 3 is activated, the clarified water is pumped in the outlet,	Discharging
Pause	Valve 2 is activated, the bioreactor is aerated at intervals (considerably lower aeration than in the "aeration" phase),	Cycle-pause
Vacation	Valve 2 is activated, the bioreactor is aerated at intervals, no clarification cycle is processed.	Vacation operation
xx day	Indication of remaining time	Rest: Xx days

## 6. Operation of the control unit

Operation of the control unit is principally executed via keypad.



Picture 7 View of control panel

Symbol	Keypad mode	Function	Symbol
	Enter	Selection of operating mode, confirmation of entries	
	Scroll	Indication of operating modes and reading information	
	Acknowledge	Fault signals, acknowledging entries without storing them acknowledging fault reports	
—	Numerical keys	Programming of the plant via entry of numbers	<b>0 ... 9</b>

## 6. Operation of the control unit

### 6.1 Connections at the control unit

On the back of the control unit Klaro and on the bottom side of the control unit Klaro light the connecting plugs and fuses are to be found.

**Caution:** When performing any kind of work at the electrical system, the main switch has to be turned to position „0“ (OFF) and the power plug must be disconnected!

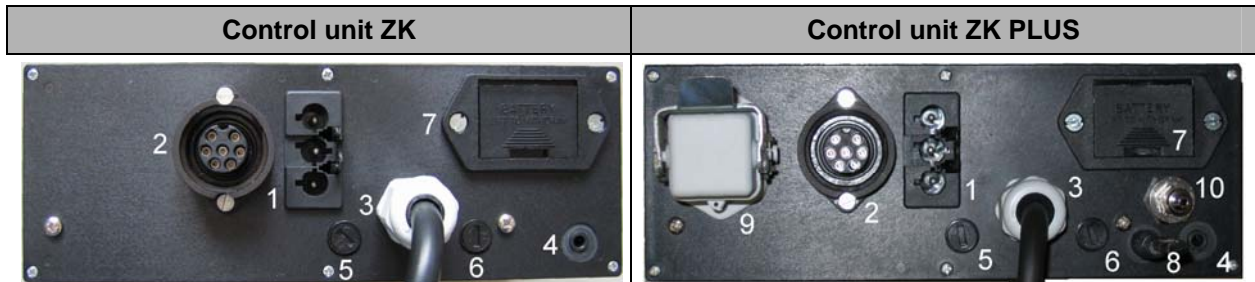

Picture 8 View of back of control unit ZK

Picture 11 View of back of control unit ZK plus

#### Connections:

- 1 Connection for power line 230 V AC ~ 50 Hz,
- 2 X1: Bayonet cap for the magnetic valves,
- 3 X2: Shockproof coupling for the connection of the air compressor,
- 4 COM: Connection for communication module, (optional) or interface for PC,
- 5 F1: T8A fuse 8 ampere, medium slow-blow, for power connection,
- 6 F2: T2A fuse 2 ampere, slow-blow, for the connected consumers,
- 7 Batt: Battery compartment for 9V battery (recommended: alkali-manganese battery!)

#### Connections:

- 1 Connection for power line 230 V AC ~ 50 Hz,
- 2 X1: Bayonet cap for the magnetic valves,
- 3 X2: Shockproof coupling for the connection of the air compressor,
- 4 COM: Connection for communication module, (optional) or interface for PC,
- 5 F1: T8A fuse 8 ampere, medium slow-blow, for power connection,
- 6 F2: T2A fuse 2 ampere, slow-blow, for the connected consumers,
- 7 Batt: Battery compartment for 9V battery (recommended: alkali-manganese battery!)
- 8 Connection for temperature sensor,
- 9 X3: Connection for extension cable ZK plus,
- 10 P: Connection for pressure-measuring hose.

## 6. Operation of the control unit

### 6.2 Changing fuses

**Before changing the fuses the plant has to be switched off by using the red main switch!**

In order to change or check the fuses, the switch and control cabinet has to be opened with the key included in the delivery.

On the back of the control unit there are the microfuses described above.

**Fuses used:**

Microfuse	230 V / 50 Hz
Feed line F1	8 A, medium slow-blow
Consumer F2	2 A, slow-blow

In order to change the microfuses please proceed as follows:

- Turn the head of the fixture with a screw-driver (exerting slight pressure) by one quarter-turn to the left (counter-clockwise).
- Remove the head of the fixture with the fuse.
- Change the fuse.
- Put the head with the fuse in the opening of the fixture.
- Press slightly on the head of the fixture with a screw-driver and fix the fuse by turning the head by one quarter-turn to the right (clockwise).

### 6.3 Battery for power failure warning device

When the plant is delivered to the customer, the battery for the power failure warning device of the control unit is in the assembly kit attached to the control cabinet. The battery has to be inserted in the compartment on the back of the control unit. You can do so before or after turning on the control unit. If no battery is inserted before turning on the control unit, there will be a fault report which may be











acknowledged by pressing . In case of power failure a charged battery is sufficient for signalling the power failure for approx. 35 hours. If the battery is not used up by power failures, natural self-discharging will occur. If the control unit does not automatically indicate that the battery has to be changed (fault report „change battery“), a change of battery is recommended after 2 years. Due to longer durability and less self-discharge 9V alkali-manganese-batteries (alkaline battery 6LR61, e. g. Duracell type MN1604) should be used.

**Important note:** Even in case of a missing or discharged battery the control unit remains fully operative. Only the setting of time / date is lost during power failure. All stored data such as operating hours, programme settings etc. remain stored.

## 6. Operation of the control unit











### 6.4 Operating the control unit

You can start various readings from automatic operation.

Control unit ZK		Control unit ZK PLUS	
<p>By pressing  you reach the first operating level. You may now receive the different readings by pressing the two arrow keys   and subsequent pressing of  :</p>		<p>By pressing  you reach the first maintenance level.</p> <p>You may now receive the different readings by pressing the two arrow keys   :</p>	
Display	What it means	Display	What it means
Operational state	Current work phase	Operational state	Current work phase
Remaining time	Remaining time	Remaining time	Remaining time
Indicate	Indication of operating hours of the individual valves and the compressor	Operating hours	Indication of operating hours of the valves, the compressor, the cabinet aeration, the UV reactors and the pump for phosphate precipitation
Operating hours		Meter reading	
Manual operation	Manual activation of the valves	Manual operation	Manual activation of the valves
Hh:mm dd dd-mm-yy	Current time, day and date can be set via 	Date	Current time and date can be set via 
Enter	Setup of vacation operation (maximum of 90 days)	Operation	Enter date for vacation operation
Vacation		Date	
Setup	Via arrow keys the current settings can be viewed	Time	Via arrow keys the current settings can be viewed
Operation code	For qualified personnel	Vacation	For qualified personnel
Service mode	For qualified personnel	Date setup	For qualified personnel
Hh:mm dd dd-mm-yy	Current time, day and date can be set via 	Indicate settings	For qualified personnel
		Operation code	For qualified personnel
		Enter	For qualified personnel
		Service code	For qualified personnel
		Manual operation	Manual activation of the valves
		Operation	

## 6. Operation of the control unit

### 6.4.1 Reading of operating hours

Control unit ZK	Control unit ZK PLUS
<p>Press the  - key. On the screen will appear:</p> <div data-bbox="204 477 472 560" style="border: 1px solid black; padding: 5px; width: fit-content;"><p>Indicate operat.hours</p></div> <p>By pressing  again, you will receive the operating hours for the valves 1-4 successively by pressing the arrow keys  . Afterwards the total number of operating hours of the compressor will be indicated.</p> <p>By pressing  once, you will return to "indicate operating hours".</p> <p>By pressing , you will reach the menu „manual operation“.</p>	<p>Press . On the screen will appear:</p> <div data-bbox="831 477 1099 560" style="border: 1px solid black; padding: 5px; width: fit-content;"><p>Operating hours Meter reading</p></div> <p>By pressing  again, the number of operating hours of valve 1 (charging) will be indicated. By pressing the arrow keys  , you will successively receive the operating hours of the other valves, of the compressor, the cabinet aeration, the UV light and the pump for phosphate precipitation.</p> <p>By pressing the key  once, you will return to the maintenance level. By pressing the key once more, automatic operation will be set again.</p> <p><b>Note:</b> If you do not press a key for 10 minutes, normal operation will be set automatically.</p>















## 6. Operation of the control unit

### 6.4.2 Manual activation of the valves via „manual operation“

**Note** → The voltage of the battery which supplies the control should the mains fail is checked by selecting manual mode. The “Change battery” message may therefore appear when manual mode is selected. This message can be acknowledged using the Esc button. If the level measurement is active when valve 1 is switched on, the control automatically measures the water level in the sludge accumulator buffer.

If the measurement is deactivated, the valves are activated as normal. Each valve should run for at least 5 seconds when testing because it takes some time to monitor the power consumption of valves before a fault is detected. After the valves, the cabinet fan (if fitted) can also be activated and checked.















**Note:** If no button is pressed for 10 min., the control automatically switches back to automatic mode

Control unit ZK	Control unit ZK PLUS
<p>Press  in automatic operation, then press the arrow key  until the following will appear in the display:</p> <div data-bbox="204 855 472 936" style="border: 1px solid black; padding: 5px; width: fit-content;"><p>Manual operation</p></div> <p>By pressing the -key again, you will receive the following indication:</p> <div data-bbox="204 1057 472 1137" style="border: 1px solid black; padding: 5px; width: fit-content;"><p>Valve1 OFF</p></div> <p>By pressing  you can switch on or off the selected valve.</p> <p>By pressing the arrow keys   the individual valves can be activated. By pressing  once, you will return to the indication „manual operation“.</p> <p><b>Important note:</b> When leaving the menu <i>manual operation</i>, all valves should be set to “OFF”.</p>	<p>Press , then press the arrow key  until the following will appear in the display:</p> <div data-bbox="833 801 1107 882" style="border: 1px solid black; padding: 5px; width: fit-content;"><p>Manual operat. Function</p></div> <p>By pressing  again and selection with the arrow keys  , manual operation for all operating modes can now be set.</p> <p>For valve 1, for example, the screen indication will read as follows:</p> <div data-bbox="833 1133 1107 1214" style="border: 1px solid black; padding: 5px; width: fit-content;"><p>Manual operat. Valve1: OFF</p></div> <p>By pressing the numbers „1“ for „ON“ and „0“ for „OFF“ you can switch on or off valve 1 by manual operation. The same procedure applies to the other valves. The selection is made as described above by the arrow keys  .</p> <p>By pressing the -key once, you will return to the maintenance level. By pressing the key once more, automatic operation will be set again.</p> <p><b>Note:</b> When leaving the menu <i>manual operation</i>, all valves should be set to „OFF“.</p>



## 6. Operation of the control unit

### 6.4.3 Setting date/time











Control unit ZK	Control unit ZK PLUS
<p>Press , then press the arrow keys   until the following will appear on the screen (example):</p> <div style="border: 1px solid black; padding: 5px; width: fit-content;"> <p>20:15 Mo 19-12-07</p> </div> <p>By pressing , time and date can be set. To confirm the correction,  has to be pressed each time as well.</p> <p>By pressing  once, you will move on to vacation operation. By pressing , you will return to manual operation.</p>	<p>Press , then press the arrow keys   until the following will appear on the screen (example):</p> <div style="border: 1px solid black; padding: 5px; width: fit-content;"> <p>19-12-2007 Mo 20:15:56</p> </div> <p>By pressing , time and date can be set. To confirm the correction,  has to be pressed each time as well.</p> <p>By pressing  once, you will move on to vacation operation. By pressing , you will return to manual operation.</p>

For fault-free operation of the plant a correct setting of time and date is not required. Time and date are only necessary in order to trace faults, if any.









**Note:** If you do not press a key for 10 minutes, normal automatic operation will be set automatically.

### 6.4.4 Setting vacation operation

**Note:** Vacation operation results in a reduced operation of the sewage treatment plant. Vacation operation should only be set if no sewage water is discharged in the sewage treatment plant in the chosen period of time. Sewage water which is discharged into the plant during vacation operation is not clarified. Vacation operation is automatically switched on and off on the dates you entered.

<p>Press , then press the arrow keys   until the following will appear on the screen:</p> <div style="border: 1px solid black; padding: 5px; width: fit-content;"> <p>Vacation Setup</p> </div> <p>By pressing  again, the setup of vacation dates is confirmed:</p> <p><b>Beginning of vacation:</b></p> <p>By pressing   day, month and year will be set in the DD-MM-YY format. After each entry of day, month or year  has to be pressed.</p>	<p>Press , then press the arrow keys   until the following will appear on the screen:</p> <div style="border: 1px solid black; padding: 5px; width: fit-content;"> <p>Setup Vacation Date</p> </div> <p>By pressing the - key again, the setup of vacation dates is confirmed:</p> <div style="border: 1px solid black; padding: 5px; width: fit-content;"> <p>Vacation Beg.: 21-05-2007</p> </div>
--	---

## 6. Operation of the control unit

Control unit ZK	Control unit ZK PLUS
<p><b>End of vacation:</b></p> <p>By pressing   day, month and year are entered in the DD-MM-YY format. After each setup of day, month or year  has to be pressed.</p> <p>By pressing , you will end the setup of dates for vacation operation and store them.</p> <p>By pressing  you will return to the indication of automatic operation.</p>	<p>Press the - key again and enter the ending date of vacation operation with the numerical keys:</p> <div style="border: 1px solid black; padding: 5px; width: fit-content; margin: 10px 0;"> <p>Vacation End: 21-05-2007</p> </div> <p>Store the setup of dates for vacation operation by pressing the - key and exit this mode.</p> <p>→ Vacation operation can be set for a maximum of 90 days.</p> <p>By pressing  once, you will return to the maintenance level. Pressing the key once more, will reset the plant to automatic operation.</p> <p>In order to jump back to automatic operation during vacation operation, the number „0“ has to be pressed.</p> <p><b>Note:</b> If you do not press a key for 2 minutes, normal operation will automatically be reset without storing the date just entered.</p>

### 6.4.5 Reading out errors – Reading out all faults

The controller saves fault messages and operation of the valves via the "Manual mode" function in the logbook. Past fault messages can be called up via this function with the date and time. The individual messages can be called up using the arrow keys. The menu point can be exited again via "Esc".

**Note:** 128 fault messages can be saved. When this number has been reached, the oldest message is deleted to make room for a new one each time. The maintenance specialist can clear the memory in the Service menu via the "Empty logbook" command.

### 6.4.6 Reading out settings

The controller's current settings can be read out under this menu point. It is not possible to change these settings. This menu point is mainly used to analyse the settings, without making any changes.

Control unit ZK	Control unit ZK PLUS
<p><b>6.4.7 Service mode</b></p> <p>Operating parameters can be changed in the service menu. Access is protected by a code figure. This second maintenance level is exclusively reserved to qualified personnel!</p>	<p><b>6.4.8 Enter service code</b></p> <p>Operating parameters can be changed in the service menu. Access is protected by a code figure. This second maintenance level is exclusively reserved to qualified personnel!</p>

**In case of unauthorised interference with the control settings the warranty claim will expire!**

## 7. Additional functions of the control unit ZK plus

By connecting an additional cable to the X3 connection, the functions of the control unit can be extended.

The following extensions are possible:

- ST5 connection of a phosphate dosing pump,
- ST6 connection of an external warning device,
- ST7 monitoring of protection for three-phase current compressor,
- ST8 connection of a UV reactor.

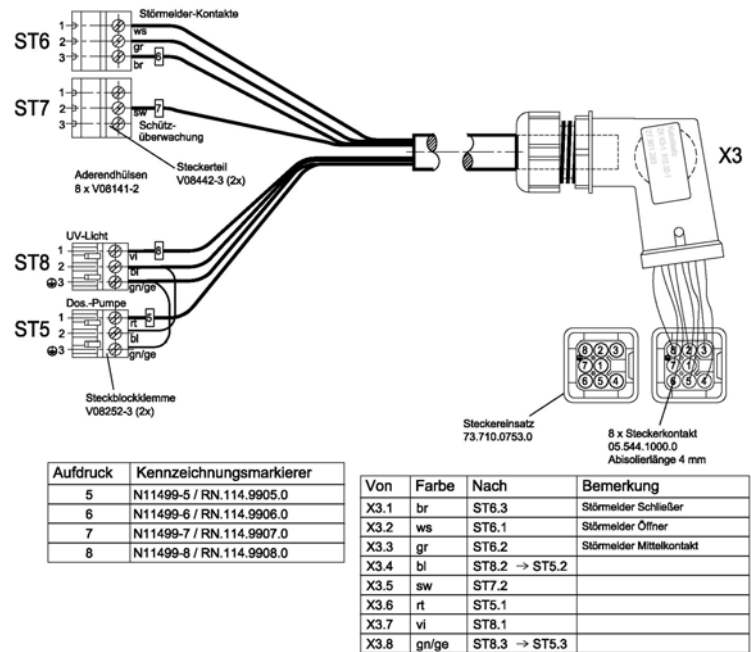

## 8. Maintenance and operation

As operator of a small sewage treatment plant you are obliged to provide for fault-free operation. Almost all operating faults lead to a deterioration of the plant's clarification performance. Therefore any faults have to be recognised at an early stage and must be removed by you or a qualified maintenance mechanic.

### 8.1 Tasks of the operator

Measured values, deviations from setpoint values and operating faults must be entered in an operations book. The water authority can demand to inspect this operations journal. The following inspections must be carried out in order to guarantee fault-free operation:

#### Daily inspection

- It is necessary to check whether the plant is operating correctly. This is the case if the operating monitor is illuminated green and no warning signal can be heard. A fault is displayed as described in the Plant Control chapter. In the event of a fault, we request that you read off the liquid crystal display and notify the service staff of the displayed fault or, if possible, remedy it yourself.

#### Weekly inspections (weekly inspections are not stipulated, but are recommended)

- Check the infeeds and outlets for blockages (visual inspection),
- Read off the hourmeters for the air compressor (total operating hours), the ventilation (Valve 2), the sludge return (Valve 4) and, if necessary, the other units also. Note the readings in the operations journal.
- Check the function of the siphons and the ventilation via the "Manual mode" setting

#### Monthly inspections

- Visual inspection for any disturbed sludge, cloudiness or discoloration in the outlet.
- Check the infeeds and outlets for blockages (visual inspection),
- Read off the hourmeters for the air compressor (total operating hours), the ventilation (Valve 2), the sludge return (Valve 4) and, if necessary, the other units also. Note the readings in the operations journal.
- **Air filter inspection:**  
The filter of the control cabinet ventilator (ventilation grille on the left and right in the housing wall in the case of the inner cabinet, and on the rear side in the case of the outer cabinet) must be inspected, and cleaned / replaced as necessary. This requires removal of the grille on the outside of the cabinet. The clip fastener can be released by gently pressing it with a screwdriver, and the grille can be removed manually. The filter mat is not secured in the ventilation shaft by any other means, and can be shaken or blown out. When the air compressor's filter must be cleaned or replaced depends on the extent of the contamination caused by the atmospheric conditions during use. To inspect or replace the filter on the compressor, proceed as instructed in the compressor manufacturer's service documents contained in the Appendix.

## 8. Maintenance and operation

### Sludge emptying

The maintenance specialist measures the level of the sludge collected in the sludge reservoir using a sludge plunging siphon. The plant is designed so that the sludge reservoir space is sufficient for at least 12 months under permanent full-load operation and with all operator and maintenance obligations being met. This period is extended accordingly under lower load. According to DIN, "de-sludging as required" applies, i.e. if an increased sludge level is detected during maintenance, the plant must be shut down for this purpose. Allowance must also be made for the floating sludge when measurements are taken. The sludge must be disposed of no later than when the sludge reservoir is 70% full. The operator must arrange for disposal of the sludge.

If maintenance and sludge removal coincide, the sludge must be removed following the maintenance. Sludge removal must be noted in the operations book. Please also follow the instructions of your specialist company here.

#### The flowing points must be noted for sludge removal:

- **Firstly**, the floating sludge is sucked off the surface, **then** the suction pipe is applied to the bottom of the pit.
- **A residual amount of water (approx. 10 cm) should be left at the bottom in the preliminary settling tank.**
- **After emptying, the preliminary settling tank must be refilled with fresh water!**

### 8.2 Maintenance by a maintenance expert

Maintenance has to be executed at least twice (three times) per year (at intervals of approx. 4/6 months) by an authorised company (expert company)<sup>1</sup> depending on the chosen discharge class. Moreover the time intervals and required tasks stipulated in the discharge approval by the local water authority are applicable. For this purpose the owner of the plant has to conclude a maintenance contract with a qualified expert.

- The following tasks have to be executed within the scope of maintenance:
- Inspection of the operating manual and ascertainment of regular operation (target-performance comparison),
- Control of the air filter of the air compressor and check of the air supply and exhaust openings of the switch cabinet,
- **Maintenance of the air compressor according to the manufacturer's stipulations (see attachments!).**
- Function control of the important operative machine, electronic and other components of the plant such as: ventilator, lifter, control unit, valves, alarm device and battery of the power failure warning device,
- Control of the sludge level in the sludge storage basin. If necessary the operator has to initiate the discharge of sludge (instructions see point 8.1),
- Execution of general cleaning work, e. g. the removal of deposits,
- Inspection of the state of the plant's components
- Control of sufficient aeration and deaeration,
- Check in the fluid bed tank:
  - Oxygen concentration ( $O_2/l > 2 \text{ mg}$ ) if necessary adjustment of the compressor's operating hours,
- Check in the final sedimentation
  - Measurement of the sludge level to verify the functioning of the excess sludge lifters. From a level of 50 cm the sludge has to be pumped backwards into the pre-treatment.

---



<sup>1</sup> Expert companies are companies independent of the plant's operator; based on their vocational training and participation in pertinent qualification measures, their staff (expert personnel) has the required qualification for the operation and maintenance of small sewage treatment plants.

## 8. Maintenance and operation

- Sampling from the outlet and analysis of the following values:
  - temperature of the sewage water,
  - sedimenting substances,
  - pH value,
  - smell,
  - colour,
  - water transparency,
  - BOD<sub>5</sub> (in every 2<sup>nd</sup> maintenance),
  - COD value,
  - NH<sub>4</sub>-N (if required),
  - N<sub>anorg</sub> (if required),
  - P (if required).

Executed maintenance work as well as any possible damages found, executed repair and other measures have to be summarised by the maintenance company in a maintenance report. A corresponding form is attached. The results of the inspections also have to be documented in the maintenance report. The maintenance report has to be handed to the plant's operator so that it can be submitted to the water authority in charge upon request. The maintenance report has to be attached to the operating manual. Please keep your operating manual ready and accessible.

## 9. Fault indications and fault repair

Technical faults of the plant's operation (failure of an aggregate) are indicated optically as well as acoustically. The acoustic fault signal of the control unit can be turned off by pressing . The optical fault indication is acknowledged only after pressing  a second time.

In case of a power supply failure an integrated network-independent power failure warning device emits an acoustic warning signal. In this case no optical indications will appear on the control unit. It is a precondition that the control unit is equipped with a sufficiently charged battery.

### 9.1 Fault indication in the display

- Fault indication as text in the liquid crystal display,
- Operating control light is „red“.

LCD display indication		Possible cause	How to remove the fault
ZK	ZK plus		
No display indication	No display indication	Power supply interrupted	<ul style="list-style-type: none"> <li>– Check power supply to the plant and the control unit</li> <li>– Check fine fuse F1 at the feed line</li> <li>– Check position of the main switch (position 1)</li> </ul>
Change batt.	Change batt.	There is no battery in the battery compartment of the control unit.	<ul style="list-style-type: none"> <li>– Insert 9V battery block in the control unit</li> <li>→ Without inserted battery a power failure is neither indicated acoustically nor optically.</li> </ul>
Set clock	Set clock	Internal clock/date not set	<ul style="list-style-type: none"> <li>– Set date and time via menu item</li> </ul>
Valve 2 Error	**Error** Valve 2	Valve 2 inoperative	<ul style="list-style-type: none"> <li>– Check valve 2 by manual operation</li> <li>– Check fine fuse of the consumers F2</li> </ul>
Valve 3 Error	**Error** Valve 3	Valve 3 inoperative	<ul style="list-style-type: none"> <li>– Check valve 3 by manual operation</li> <li>– Check fine fuse of the consumers F2</li> </ul>
-	Temperature max	<ul style="list-style-type: none"> <li>– Cabinet aeration inoperative</li> <li>– Filters in the cabinet and in the compressor are polluted.</li> <li>– Direct sunlight on the cabinet</li> <li>– Excessive temperatures for the switch-on of the cooling ventilator and an excessive maximum temperature are set in the service menu</li> <li>– Air compressor defective</li> </ul>	<ul style="list-style-type: none"> <li>– Check operability of the cabinet aeration</li> <li>– Check air filter in the cabinet</li> <li>– Provide shadow for location</li> <li>– Provide cool air</li> <li>– Check air filter in the air compressor</li> <li>– Check air compressor by manual operation</li> <li>– Have maintenance company check set temperatures.</li> </ul>

## 9. Fault indications and fault repair

### 9.2 Unusual water levels – Fault repair

Fault noticed	Possible cause	How to remove the fault
The water level in one of the tanks is higher than in the other one.	– The overflow baffle is congested.	– Clean the overflow baffle and delete the blockage.
The plant is smelly, the clarified sewage water is turbid or discoloured.	– Insufficient amount of air entering the plant. – Uneven aeration due to defective membrane unit	– Have aeration period increased by service company – Check of visible impression of aeration, contact maintenance company
Aeration appears to be uneven and large air bubbles ascend in some places.	– The membrane unit is defective. – The aeration bar seal is leaky.	– Contact maintenance company – Contact maintenance company
Magnetic valves are unusually loud when switched.	– The valve seat of the magnetic valve is soiled.	– Unscrew and clean magnetic valve

#### 9.2.1 Cleaning solenoid valves

Following extended use, dirty switching elements can impair perfect functioning. One indication of this can be an increased noise level in the actuated solenoids. The solenoid valves must be unscrewed in order to clean them. When assembling them, make sure that the anchor and the return spring are positioned straight.

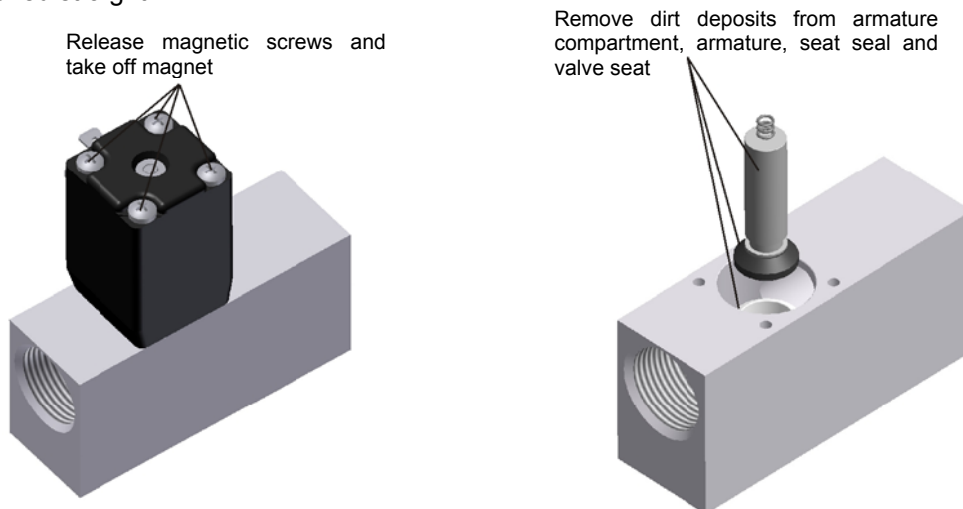





## 9. Fault indications and fault repair

### 9.3 Mode of operation of the power failure warning device

Regardless of the cause of the power failure (also blowing of internal fuse or separation from the plug) the warning device sounds acoustic signals when detecting a power failure in the control unit.

With a 5-second delay the device responds to a power failure. This is to avoid that short failure, which for instance occur several times during a thunderstorm but do not impair the overall function of the sewage treatment plant, are unnecessarily signalled.

- After the 5-second delay there is an intermittent beep with a 10-second delay for approx. 35 hours (when the battery is fully charged).
- The signal can be stopped by pressing . After that three short beeps per hour signal the power failure. These short beeps, however, cannot be stopped.
- After pressing  for 5 seconds, the signal will be completely deactivated.
- Turning off the device is only possible after taking out the battery.
- The return of power supply will reset the device to the monitoring state without pressing any further keys.

The fuses can be changed as already described.

**Note:** If you cannot solve the problem, please contact your maintenance company or Otto Graf GmbH in Teningen as soon as possible.

## 10. Operating instructions

Only substances with characteristics corresponding to domestic sewage water are supposed to be discharged into the plant.

Biocides, toxic or biologically incompatible or non-decomposable substances must not be discharged into the plant as they cause problems in the biological processes. The following, in particular, must not be discharged into the plant:

- Rain water from roofs or courtyards,
- Miscellaneous water (e. g. drain water),
- Solid and liquid remains from animal husbandry,
- Commercial or agricultural sewage water, unless comparable to domestic sewage water,
- Chemicals, pharmaceuticals, mineral oils, solvents,
- Cooling water,
- Rough substances such as food remains, plastics and sanitary products, coffee filter bags, bottle caps and other household articles,
- Milk and dairy products,
- Outlet water of swimming pools,
- Larger quantities of blood.

If larger quantities of grease or vegetable oils accumulate, it is recommendable to clarify the sewage water containing grease in a grease separator which is preceding the sewage treatment plant (Caution: No faeces may be discharged into the grease separator!).

## 10. Operating instructions

The following chart lists individual substances which must not be discharged into the sewage treatment plant:

<b>Solid or liquid substances which are not supposed to be discharged into the sink or the toilet:</b>	<b>Their effect:</b>	<b>Where to take them:</b>
<b>Ashes</b>	Do not decompose	Dustbin
<b>Chemicals</b>	Contaminate the sewage water	Garbage collection point
<b>Disinfectants</b>	Kill bacteria	Do not use them
<b>Paint</b>	Contaminates the sewage water	District garbage collection point
<b>Photo-chemicals</b>	Contaminate the sewage water	District garbage collection point
<b>Frying grease</b>	Causes sediments in pipes and leads to congestions	Dustbin
<b>Adhesive plaster</b>	Congests pipes	Dustbin
<b>Cat litter</b>	Congests pipes	Dustbin
<b>Cigarette stubs</b>	Cause sediments in the plant	Dustbin
<b>Condoms</b>	Congestions	Dustbin
<b>Corks</b>	Cause sediments in the plant	Dustbin
<b>Lacquers</b>	Contaminate the sewage water	District garbage collection point
<b>Pharmaceuticals</b>	Contaminate the sewage water	Garbage collect. points, pharmacies
<b>Motor oil</b>	Contaminates the sewage water	Garbage collect. points, gas stations
<b>Waste containing oil</b>	Contaminates the sewage water	Garbage collect. points, gas stations
<b>Pesticides</b>	Contaminate the sewage water	District garbage collection point
<b>Paintbrush cleansers</b>	Contaminate the sewage water	District garbage collection point
<b>Cleansers except those which are chlorine-free (ecologically compatible)</b>	Contaminate the sewage water, make pipes and seals corrode	District garbage collection point
<b>Razor blades</b>	Risk of injury for workers in the sewer system and the sewage works	Dustbin
<b>Tube cleaners</b>	Make pipes and seals corrode, contaminate the sewage water	District garbage collection point
<b>Insecticides</b>	Contaminate the sewage water	District garbage collection point
<b>Sanitary pads</b>	Cause congestions, non-decomposable plastic foil spoils rivers and lakes	Dustbin
<b>Edible oil</b>	Causes sediments and congested pipes	District garbage collection point
<b>Food remains</b>	Cause congestions, attract rats	Dustbin
<b>Wallpaper paste</b>	Causes congestions	District garbage collection point
<b>Textiles (e. g. nylon stockings, cleaning rags, handkerchiefs etc.)</b>	Congest pipes, may stop a pumping station	Collection of old clothes
<b>Diluters</b>	Contaminate the sewage water	District garbage collection point
<b>Bird grit, cat litter</b>	Causes sediments and congested pipes	Dustbin
<b>Cotton swabs</b>	Congest the plant	Dustbin
<b>Toilet bowl deodorizers</b>	Contaminate the sewage water	Do not use them
<b>Diapers</b>	Congest the pipes	Dustbin
<b>Cement water</b>	Causes sediments, creates concrete layer	Get an expert company to dispose of it

Thank you for your confidence.

Otto Graf GmbH, Teningen (Germany).

Status 04/2009

*Technical changes reserved.*







## 12. Maintenance minutes for GRAF small sewage treatment plants

**Location (address):** \_\_\_\_\_

Maintenance company:	_____	Date of maintenance:	_____
Serial number:	_____	Order No.:	_____
Size of plant:	_____ PE	Actual No. of people:	_____ PE
Name of operator:	_____	Customer No.:	_____
Street:	_____	Phone No.:	_____
ZIP code/place:	_____	Phone No.:	_____
Installed by:	_____	Initial operation:	_____

**Is commercial sewage water discharged as well?**

no

Pub without kitchen       Pub with kitchen       Other \_\_\_\_\_

Grease separator available, NS       Emptying necessary

**Constructive state (optical inspection of the tank's body when filled):**

Separation walls are all right       Tank is tight towards the outside

Free from visible damage

Remarks: \_\_\_\_\_

**Function control of the important operative parts of the plant:**

Aeration / Valve 2 (blue)

Sludge lifter / Valve 3 (black)

Power failure warning device (optional)

Air supply / aeration:       moderate       intense, circulation clearly recognisable

Opt. impress. / aeration:       fine bubbles       even

Remarks: \_\_\_\_\_

**Sludge storage basin + buffer:**

Sludge level: \_\_\_\_\_ cm      Floating sludge level: \_\_\_\_\_ cm

The operator should initiate emptying of the sewage treatment plant

Fluid bed tank:

Oxygen concentration: \_\_\_\_\_ mg/l (normal approx. 4-6 mg/l at least 2 mg/l)

Remarks: \_\_\_\_\_

**Control unit:**

Control unit type: \_\_\_\_\_       $\Sigma$  operating hours: \_\_\_\_\_

Discharging (Valve 3): \_\_\_\_\_      Aeration (Valve 2): \_\_\_\_\_

Remarks: \_\_\_\_\_

**Blower:**

- Blower type: \_\_\_\_\_  Blower is all right  
 Exchange of lamellae (length of lamellae: \_\_\_\_\_ mm)  Exchange of membranes  
 Exchange of filter  Cooling aeration is all right

Remarks: \_\_\_\_\_

**Time of sampling:**

Date \_\_\_\_\_ Time \_\_\_\_\_

Sampling location: \_\_\_\_\_  Sampling shaft  final sedimentation

Sample transportation: \_\_\_\_\_  cooled 4°C  frozen

Air temperature: \_\_\_\_\_ °C Water temperature: \_\_\_\_\_ °C

Smell  no  weak  strong  foul  earthy

Colouration  no  weak  strong  beige  brown

Turbidity  no  weak  strong  opaque

Floating substances  none  few  many

**Dry substances**

Sedimenting substances	_____	ml / l	pH value	_____
BOB <sub>5</sub>	_____	ml / l	COD	_____ ml / l
NH <sub>4</sub> -N	_____	ml / l	N <sub>total</sub>	_____ ml / l

**Additional remarks:**

Operating manual is available  Maintenance was entered in operating manual.

Programming was changed: \_\_\_\_\_

Fault was repaired: \_\_\_\_\_

Additional remarks: \_\_\_\_\_

**To be initiated by the operator:**

The operator is requested to pay attention to substances which are not allowed to be discharged (see operating manual).

Tank is congested, operator has to provide for emptying.

Empty the tank (emptying of sludge storage basin).

\_\_\_\_\_  
Date and signature

### 13. Attachment I: Datasheets of the plant

**Note:**

The Becker rotary vane compressor we use has a pressure relief valve which is set to a maximum pressure of 0.5 bar in the factory.

An operating pressure of < 0.3 bar is standard for our systems. Should pressure of > 0.5 bar occur in the system (e.g. due to the air hose being bent), some of the air is blown off via the pressure relief valve. This protects the compressor from damage or excess wear.



# LINEAR



MOTOR FREE  
PISTON SYSTEM

## LA-60A LA-80A

LA-60A  
LA-80A



### Airflow Characteristics

#### LA-60A

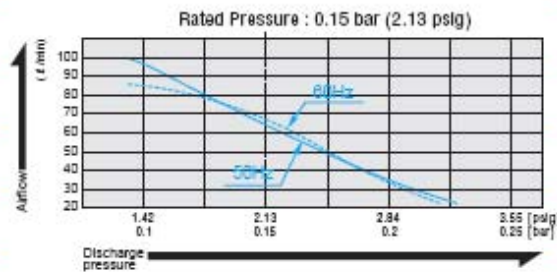

#### LA-80A

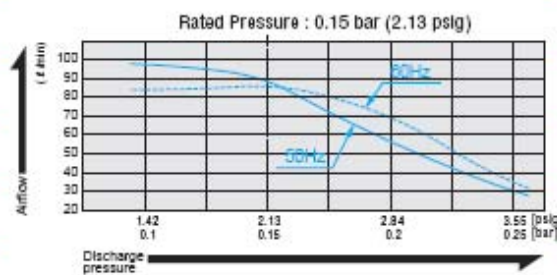

### Specifications

	LA-60A	LA-80A
Power Supply	AC 120V, 220V, 230V, 240V	
Rated Frequency	50 Hz, 60 Hz	
Rated Pressure	0.015 MPa (0.15kgf/cm <sup>2</sup> ), 0.15 bar or 2.13 psig	
Rated Airflow	60 l/min (2.12 cfm)	80 l/min (2.83 cfm)
Power Consumption	64 W / 50 Hz	86 W / 50 Hz
	60 W / 60 Hz	80 W / 60 Hz
Weight	5.0 kg (11 lbs)	5.3 kg (11.7 lbs)

\* Life expectancy is the expected accumulated period of time during which the compressor will maintain the above specifications. Contact your supplier for details of the conditions of use under which the values and numbers stated herein are maintained.

### Application Examples



Liquid Mixer Bubbling



Home Aerobic Sewage Treatment System

### Sketch Drawing and Mounting Dimensions Diagram (mm)

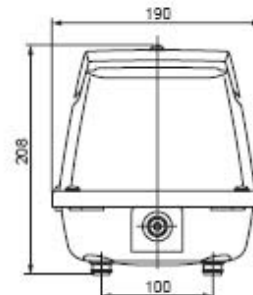
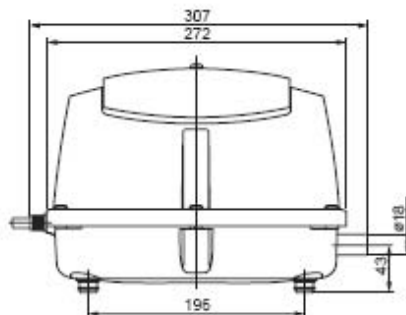

# LINEAR



MOTOR FREE  
PISTON SYSTEM

# LA-100 LA-120



LA-100  
LA-120

### Airflow Characteristics

#### LA-100

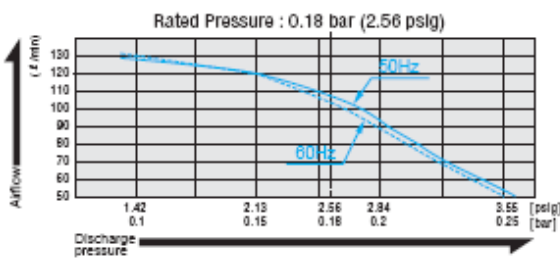

#### LA-120

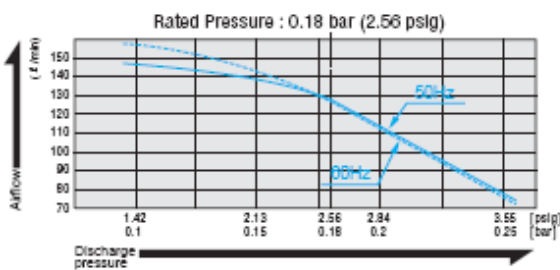

### Specifications

	LA-100	LA-120
Power Supply	AC 120V, 220V, 230V, 240V	
Rated Frequency	50 Hz, 60 Hz	
Rated Pressure	0.018 MPa (0.18kgf/cm <sup>2</sup> ), 0.18 bar or 2.56 psig	
Rated Airflow	100 ℓ /m (3.53 cfm)	120 ℓ /m (4.24 cfm)
Power	100 W / 50 Hz	130 W / 50 Hz
Consumption	95 W / 60 Hz	118 W / 60 Hz
Weight	9.4 kg (20.7 lbs)	9.4 kg (20.7 lbs)

\* Life expectancy is the expected accumulated period of time during which the compressor will maintain the above specifications. Contact your supplier for details of the conditions of use under which the values and numbers stated herein are maintained.

### Application Examples

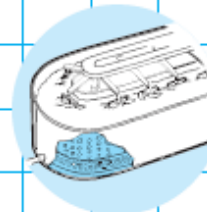

Liquid Mixer Bubbling

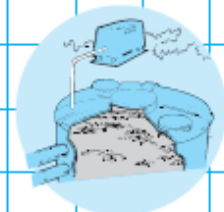

Home Aerobic Sewage Treatment System

### Sketch Drawing and Mounting Dimensions Diagram (mm)

